

DATASHEET

12F MPO-MPO TRUNK CABLE

Ideal for Data Center High Density Cabling System



OMC INDUSTRY CO.LIMITED

Description

MPO-MPO 3.0mm LSZH Patch cable/trunk cable. MPO Fiber Patch cable/trunk cable is terminated with MPO connector on both ends. MPO Patch cable/trunk cables connect MPO modules together as a permanent link. The Patch cable/trunk cables are available with 12, 24, 48,60,72 ,96,144fibers. Support speeds up to 10/40/100Gbps data center solutions. They are typically adopted to interconnect cassettes, panels or ruggedized MPO fan-outs, and to facilitate rapid deployment of high-density backbone cabling in data centers and other high fiber environments. Besides, MPO also provides much flexibility and convenience once you have to change the connector style in the patch panels. Instead of changing the connector on the cable trunk, just installing a new cassette with the new connector style on the cross-connect side of the patch panel.





The 12F MPO-MPO Patch cable/trunk cable is designed for 40G QSFP+ SR4, 40G QSFP+ CSR4 and 100G QSFP28 SR4 optics direct connections and high-density data center.

Products Materials

Connector	Reference	Housing Details
MPO Singlemode	IEC 61754-7	SM APC: Green connectors+black boot (Standard Loss MPO) SM APC: Yellow connectors+black boot (Super low loss MPO)
MPO Multimode	IEC 61754-7	OM1&OM2 PC: Beige connectors+black boot (Standard Loss MPO) OM3&OM4 PC: Aqua connectors+black boot (Standard&Super low loss MPO) OM3&OM4 PC: Heather Violet connectors+black boot (Standard loss MPO)

IEC Standard IEC-61754-7; IEC61755, Telcordia GR-1435-CORE, JIS C5982; TIA-604-5(FOCIS5) compliant
Structured cabling per TIA-568-C
10G Fiber Channel Compliant
40G and 100G IEEE 802.3

Connector	Fiber Channel
 <p>MPO (Male) - Pins MPO (Female) - No Pins</p>	 <p>12 Fibers</p>
MPO Connectors	

Note: Female connector need to connect with male connector type.

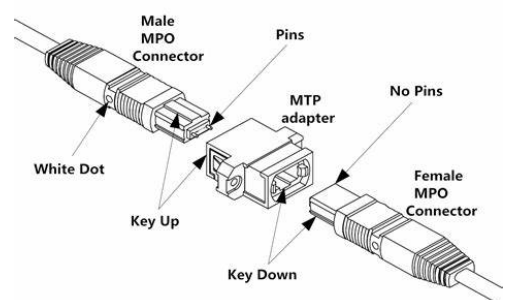

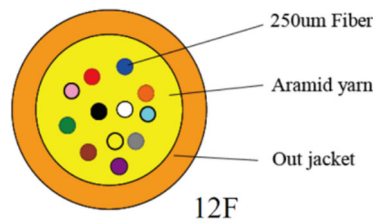
Cable Parameters-12F Microfiber cable

Fiber Count	OD(mm)	Minimum allowable Tensile Strength (N)	minimum allowable Crush Load(N/100mm)	Minimum Bending Radius(MM)
12	3.0±0.15	Short-term: 180; Long-term: 90	Short-term: 500; Long-term: 150	Static: 10D Dynamic: 20D

Optical Specifications

Spec items.	Single mode (APC 8-degree polished)	Multimode (PC Flat polish)
Insertion loss (MPO) (IEC 61300-3-34)	Standard loss: ≤0.75dB(max), ≤0.50dB (Typical) Super Low loss: ≤0.35dB(max), ≤0.20dB (Typical)	Standard loss: ≤0.6dB(max), ≤0.50(Typical) Super Low loss: ≤0.35dB(max), ≤0.20dB (Typical)
Return loss(MPO)	≥60dB (8degree polishing)	≥25dB
Durability	<0.3dBtypical change, 200 matings	
Interchangeability	≤0.2dB	
Tensile strength	>70N	
Operating Temperature	-40 to + 85°C	

MPO End-Face 3D Interference Index

Item (IEC-61300-3-30)		Minimum	Maximum	
Radius of curvature (mm)	ROC-X(ABS)	2000	\	
	ROC-Y(ABS)	50mm	\	
Angle	Angle-X	-0.2°	-0.2°	
	Angle-Y	APC	7.85°	8.15°
		PC	-0.2°	-0.2°
Fiber height (nm)		1000nm	3500nm	
Max.DH.All Fiber:		-300nm	300nm	
DH.Adj:		-300nm	300nm	
DH.Ave Fiber:		-300nm	300nm	
Core Dip:	SM	N/A	N/A	
	MM	-200nm	300nm	

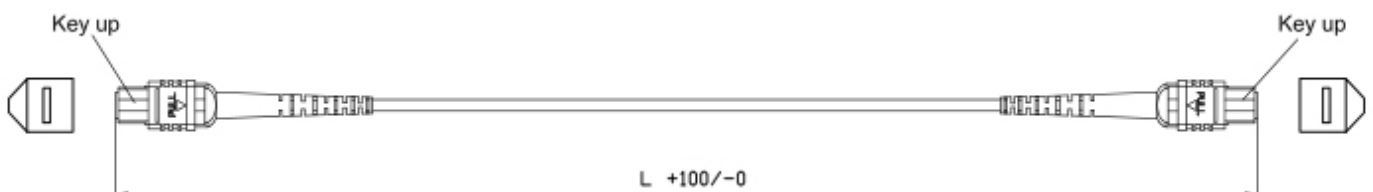
MPO-MPO 12F Trunk cable drawing.

Overall Length(L)(m)	length of tolerance(cm)
0<L<1	+5/-0
1<L<10	+10/-0
10<L<40	+15/-0
40<L	+0.5% x L/-0

Three Connection Methods Help Keep the Right MTP/MPO Polarity



1. Polarity A connection

Polarity A MPO cables use a key up, key down design. Therefore, as shown in the figure below, the position 1 of one connector is corresponding to the position 1 of another connector. There is no polarity flip. Therefore, when we use polarity A MTP cable for connection, we must use A-B duplex patch cables on one end and A-A duplex patch cables on the other end. Since in this link, Rx1 must connect to Tx1. If we don't use A-A duplex patch cable, according to the design principle of polarity A MTP cable, fiber 1 may transmit to fiber 1, that is to say Rx1 may transmit to Rx1, which may cause errors.

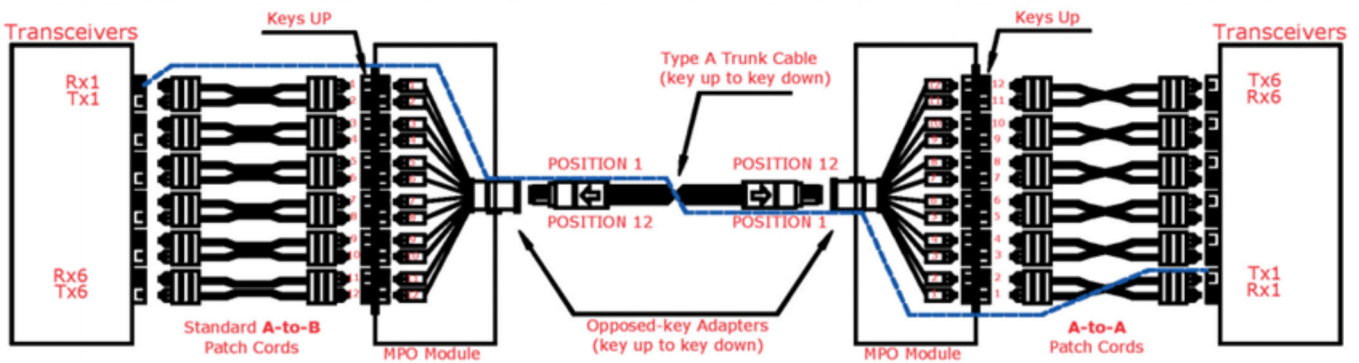

2. Polarity B connection

Polarity B MTP cables use a key up, key up design. Therefore, as shown in the figure below, the position 1 of one connector is corresponding to the position 12 of another connector. Therefore, when we use polarity B MTP cable for connection, we should use a A-B duplex patch cables on both ends. Since the key up to key up design help to flip the polarity, which makes fiber 1 transmit to fiber 12, that is the Rx1 transmits to Tx1.

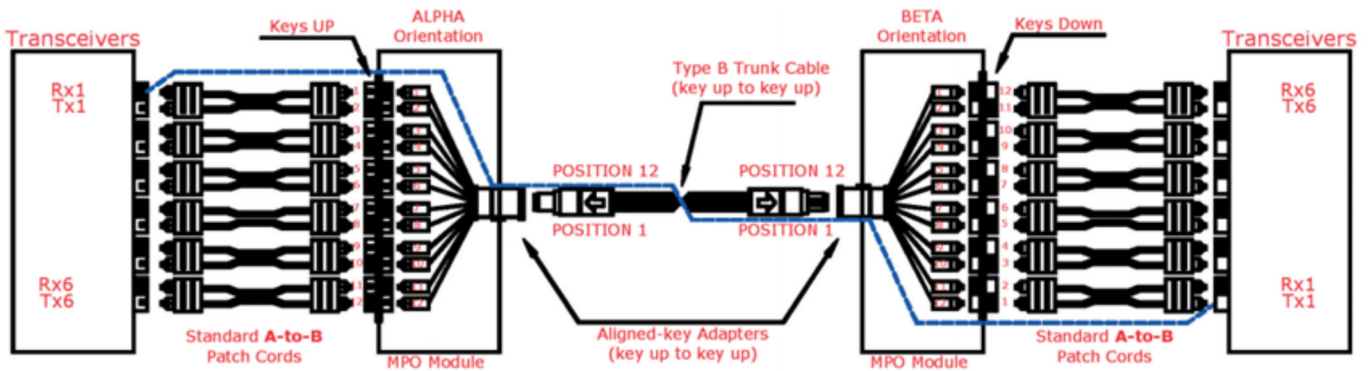

3. Polarity C connection

Like the polarity A MPO cables, polarity C MPO cables also use a key up, key down design. However, within in the cable, there is a fiber cross design, which makes the position 1 of one connector is corresponding to the position 2 of another connector. As shown in the figure below, when we use polarity C MTP cable for connection, we should use a A-B duplex patch cables on both ends. Since the cross fiber design help to flip the polarity, which makes fiber 1 transmit to fiber 2, that is the Rx1 transmits to Tx1.

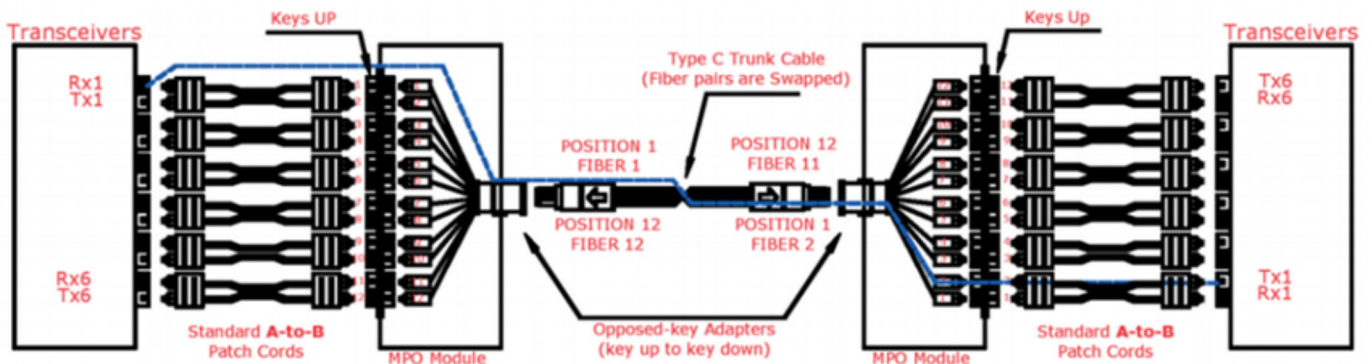

AVAILABILITY:

- Ribbon and bundle cable available;
- Patch cord, pigtail cable assemblies available.
- MT-MT ribbon patch cord is available.
- MPO Loopback Cable available

Push Pull Tab For Senko MPO

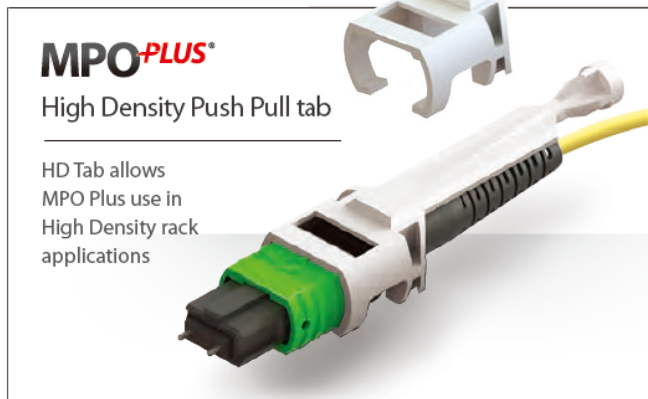
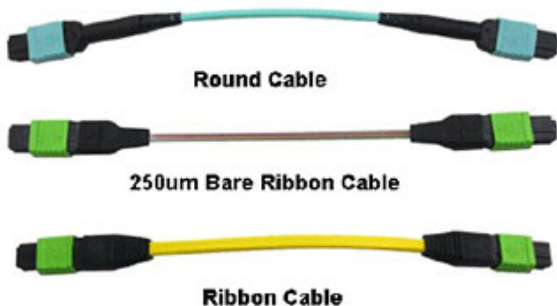

The merits of MTP/MPO Patch cable/trunk cable generally include:

High quality—MTP/MPO Patch cable/trunk cables are factory pre-terminated, tested and packaged along with the test reports. These reports serve as long-term documentation and quality control.

Decreasing cable volume—MTP/MPO Patch cable/trunk cables have very small diameters, which decrease the cable volume and improve the air-conditioning conditions in data centers.

Time saving—With the special plug and play design, MTP/MPO Patch cable/trunk cables can be incorporated and immediately plugged in. It greatly helps reduce the installation time.

Features:

Low insertion loss, high return loss

MT based Multi-fiber Connector, 4,8,12 and 24 fiber connector terminations and assemblies

Economical solution for mass-termination of fiber

Designed for low loss and standard loss SM and MM applications

Ruggedized round cable, oval cable and bare ribbon options available

Color coded housings available to differentiate fiber type, polish type and/or connector grade

Good in repeatability and exchangeability

Application

All of OMC's MPO Connectors are from Senko/Nissin/Sumitomo. MPO Patch cable/trunk cable is a kind of high density cable assemblies which is generally use in three areas.

- 1, The Data Center application with high dense degree environment
- 2, The optical fiber to the building
- 3, The internal connector application in fiber equipment.

Packaging

This easily taken and well-protected fiber patch cable package has been labelled and marked by OMC as default .Standard carton size : 34*22*15 cm; 44*34*24 cm ; 54*39*34 cm . Which carton to be used depends on goods Qty . Packing can be customized.



1,Self-seal PE Bag



2 Bubble Bag



3, Paper Carton



4,fumig-free Pallet

OME service

- 1, Cable color, printing word, material of cable jacket, connector's color
- 2, OEM Label, Identify ring, cable's label, box, shipping marks
- 3. Different quality Level.



12F MPO-MPO TRUNK CABLE

Order Index

Products	Fiber&cable	Fiber	Quality	Pin	Cable Jacket	Cable Color	Polarity	length
M1 -Senko MPO without tab	1- 8F round cable	1-G652D	1-Standard loss	1-F to F	H-LSZH	A-Blue	A-Polarity A	1-1m
M2-MTP without tab	2-12F round cable	2-G657A1	2-Super low loss	2-F to M	C-PVC	B-Orange	B-Polarity B	1.5-1.5m
M3-China MPO	3-16F round cable	3-G657A2/B2		3-M to M	F-OFNR	C-Green	C-Polarity C	2-2m
M4-Senko MPO with tab	4-20F round cable	4-G657B3			P-OFNP	D-Brown		..
M5-MTP with tab	5-24F round cable	5-BIF om1			U-PU	E-Grey		
	6-8F ribbon cable	6-BIF om2			...	F-Whitie		
	7-12F ribbon cable	7-BIF om3			...	G-Red		
	8-8F ribbon bare fiber	8-BIF om4				H-Black		
	9-12F ribbon bare fiber	9-BIF om5				I-Yellow		
						J-Purple		
						K-Pink		
						L-Aqua		
						M-Magenta		